



ETA-Danmark A/S
Göteborg Plads 1
DK-2150 Nordhavn
Tel. +45 72 24 59 00
Fax +45 72 24 59 04
Internet www.etadanmark.dk

Authorised and notified according
to Article 29 of the Regulation (EU)
No 305/2011 of the European
Parliament and of the Council of 9
March 2011

MEMBER OF EOTA



European Technical Assessment ETA-18/0447 of 2024/09/23

I General Part

Technical Assessment Body issuing the ETA and designated according to Article 29 of the Regulation (EU) No 305/2011: ETA-Danmark A/S

Trade name of the construction product:

Tecnaria CTF Nailed Shear Connector

Product family to which the above construction product belongs:

Nailed Shear Connector

Manufacturer:

TECNARIA SpA
Viale Pecori Giraldi 55
IT-36061-BASSANO DEL GRAPPA-VI
Tel.: +39 0424 502029
Fax: +39 0424 502386
Internet: www.tecnaria.com

Manufacturing plant:

TECNARIA SpA
Manufacturing Plant I

This European Technical Assessment contains:

19 pages including 12 Annexes which form an integral part of the document

This European Technical Assessment is issued in accordance with Regulation (EU) No 305/2011, on the basis of:

European Assessment Document (EAD)
200033-00-0602 Nailed Shear Connector

This version replaces:

The ETA with the same number issued on 2021-07-05

Translations of this European Technical Assessment in other languages shall fully correspond to the original issued document and should be identified as such.

Communication of this European Technical Assessment, including transmission by electronic means, shall be in full (excepted the confidential Annex(es) referred to above). However, partial reproduction may be made, with the written consent of the issuing Technical Assessment Body. Any partial reproduction has to be identified as such.

II SPECIFIC PART OF THE EUROPEAN TECHNICAL ASSESSMENT

1 Technical description of product

Technical description of the product

The nailed shear connector Tecnaria CTF is a mechanically attached shear connector for use in steel-to-concrete composite beams and in composite decks with profiled sheeting as an alternate to welded headed studs.

The CTF nailed shear connector consists of a cylindrical shank of variable height with head cold-formed from a bar with diameter 12 mm, and made from C4C steel according to EN10263-2. The head of the shank has a diameter of 18 mm and a thickness of 5 mm. The shank is connected to a base plate by cold pressing. The base plate is a rectangular 38 x 54 mm, FE DD11 metal base plate 4 mm thick, manufactured by moulding, according to EN10111. The plate has two 5 mm diameter holes through which the nails are inserted.

CTF connectors are attached to the metal support by means of two SPIT HSBR14 nails inserted into the two holes in the base plate. They are fixed using a Spitfire Spit P560 Nailer fitted with a special kit made for this purpose. The anchorage shank is embedded in the concrete deck of the composite beam. The nailed shear connector can be used for composite beams with and without profiled composite decking.

The height of the anchorage ranges from 20 mm to 135 mm in order to take the different thicknesses of the concrete slab as well as the different heights of composite deck into account.

The different models of the Tecnaria CTF are: CTF 020 to CTF 135. The number in the product designation refers to the height of the shank.

The powder-actuated fasteners SPIT HSBR14 are made of zinc plated carbon steel with ultimate tensile strength = 2300 N/mm². The fasteners comprise of a pin with a shank diameter of 4.5 mm and they are assembled with one metal washer. The washer serves to guide the fastener while it is being driven into the base material and it contributes to the shear resistance. The powder-actuated fastening tools Spitfire Spit P560 Nailer is used in order to install the SPIT HSBR14 together with the Tecnaria CTF shear connector. The driving force of the fastening tool is provided by the power load of the cartridge. The application limit of the powder-actuated fastening system depends on the strength and thickness of the base material. The fastening tools (incl.

cartridges) are an integral part of this assessment with regard to the capacity of the nailed shear connector Tecnaria CTF and the application of the respective system.

The nailed shear connectors can be placed in one or more rows along the length of the composite beams.

The shear connectors Tecnaria CTF and the powder-actuated fastener SPIT HSBR14 are detailed in Annexes A1 and A2.

2 Specification of the intended use in accordance with the applicable European Assessment Document (hereinafter EAD)

The nailed shear connector Tecnaria CTF is intended to be used as connection device structural elements made of concrete and rolled or cold-formed structural steel, connected together to prevent any longitudinal sliding between the two materials, and their separation.

The sizing of composite beams using CTF connectors must be made in accordance with Eurocodes, especially Eurocode 4.

Main applications:

Composite beams

- Steel beam + reinforced concrete solid slab;
- Steel beam + reinforced concrete slab with a haunch formed between the steel profile and the lower face of the concrete slab;
- Steel beam + slab cast on a structural steel deck;
- Steel beam + slab cast on a steel deck, used as permanent formwork;
- Steel beam + slab cast on prefabricated reinforced concrete elements.
- As part of a renovation, the connectors can be used to increase the bearing capacity of existing floors

Composite columns (profiles encased in concrete)

- CTF connectors can be used to ensure the connection between the metal core and the concrete encasement of composite steel-concrete columns.

Absorbing horizontal forces

- The connectors can be used to transmit horizontal forces between the steel beams and a concrete slab and between this concrete slab and the stability systems

Renovation

- The connectors can be used in renovation work.

- Old floors are often made from IPN or IAO beams supporting masonry slabs.
- These floors may be undersized in relation to the current building regulations.
- Tecnaria connectors can be used to transform these floors into composite steel-concrete elements (the slabs serving as permanent formwork).
- This solution has the advantage of not requiring any welding, as in the case with conventional studs, which is often difficult to achieve on old profiles.

The intended use comprises composite structures with static or quasi-static loading.

In all the configurations in which the connectors are ductile, seismic loading is covered if the CTF connector is used as shear connector in composite beams used as secondary seismic members in dissipative as well as non-dissipative structures according to EN 1998-1.

The performances given in Section 3 are only valid if the nailed shear connector is used in compliance with the specifications and conditions given in Annexes B1 to B8.

The verifications and assessment methods on which this European Technical Assessment is based lead to the assumption of a working life of the nailed shear connector of at least 50 years.

The indications given on the working life cannot be interpreted as a guarantee given by the producer or Assessment Body, but are to be regarded only as a means for choosing the right products in relation to the expected economically reasonable working life of the works.

3 Performance of the product and references to the methods used for its assessment

Characteristic	Assessment of characteristic
3.1 Mechanical resistance and stability (BWR1)	
Characteristic resistance in solid concrete decks, shear connector orientation parallel to beam axis	No Performance assessed
Characteristic resistance in solid concrete decks, shear connector orientation perpendicular to beam axis	See annex C1
Characteristic resistance in composite decks – decking ribs perpendicular to beam axis – shear connector orientation perpendicular to beam axis	See annex C2
Characteristic resistance in composite decks – decking ribs perpendicular to beam axis – shear connector orientation parallel to beam axis	No Performance assessed
Characteristic resistance in composite decks – decking ribs parallel to beam axis – shear connector orientation parallel to beam axis	No Performance assessed
Characteristic resistance in composite decks – decking ribs parallel to beam axis – shear connector orientation perpendicular to beam axis	See annex C4
Characteristic resistance of end anchorage of composite decks	No performance assessed
Characteristic resistance for use in seismic areas under seismic actions according to EN 1998-1	See annex B1
Characteristic resistance in solid concrete decks in renovation application with old metallic iron or steel material with an actual yield strength less than 235 MPa	See annex C6
Application limit	See annex B3
3.2 Safety in case of fire (BWR2)	
Reaction to fire	The anchors are made from steel classified as Euroclass A1 in accordance with EN 13501-1 and Commission Delegated Regulation 2016/364
Resistance to fire	No performance assessed

4 Assessment and verification of constancy of performance (hereinafter AVCP) system applied, with reference to its legal base

4.1 AVCP system

According to the decision 1998/214/EC the European Commission, the system(s) of assessment and verification of constancy of performance (see Annex V to Regulation (EU) No 305/2011) is 2+.

5 Technical details necessary for the implementation of the AVCP system, as provided for in the applicable EAD

Technical details necessary for the implementation of the AVCP system are laid down in the control plan deposited at ETA-Danmark prior to CE marking

Issued in Copenhagen on 2024-09-23 by



Thomas Bruun
Managing Director, ETA-Danmark

Nailed shear connector Tecnaria CTF with powder actuated fastener SPIT HSBR14

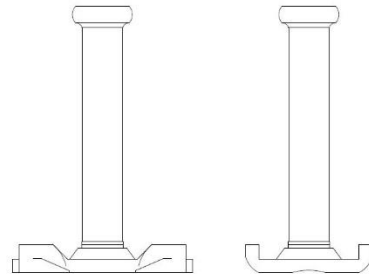
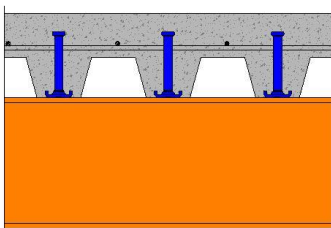
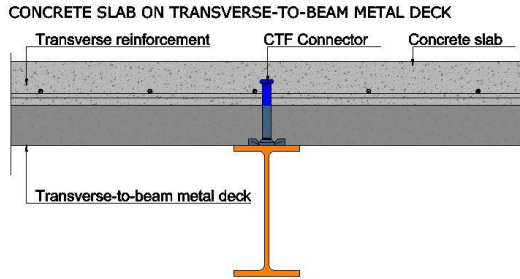

Example of intended use: Nailed shear CTF connection in composite beam

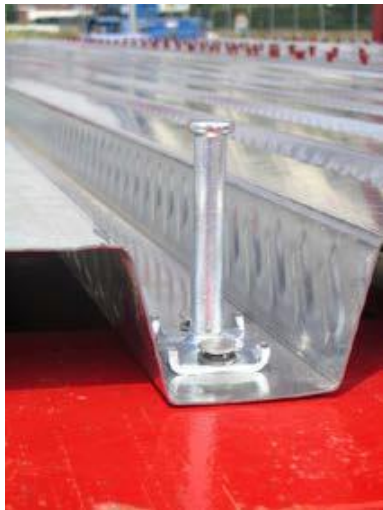

Tecnaria CTF Nailed Shear Connector

Product and intended use

Annex A1
of European
Technical Assessment
ETA-18/0447

Types of Tecnaria CTF

	CTF 12/20 Shank h=20mm 	CTF 12/25 Shank h=25mm 	CTF 12/30 Shank h=30mm 
CTF 12/40 Shank h=40mm 	CTF 12/60 Shank h=60mm 	CTF 12/70 Shank h=70mm 	CTF 12/80 Shank h=80mm 
CTF 12/90 Shank h=90mm 	CTF 12/105 Shank h=105 mm 	CTF 12/125 Shank h=125 mm 	CTF 12/135 Shank h=135 mm 

Table 1: Materials

Designation	Material
Shear connector Tecnaria CTF	Galvanised steel type C4C according to EN 10263-2 with diameter 12 mm
Base plate	Steel FE DD11 according to EN10111
Powder actuated fastener SPIT HSBR14 according to ETA-08/0040	Nail: Carbon steel Ultimate tensile strength: 2300 N/mm ² Yield strength: 1600 N/mm ² Mechanical zinc plating, min zinc coating 10 µm Hardness > 57 HRC Knurled shank Washer: min 8 µm zinc coating

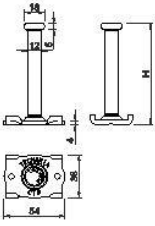
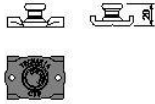
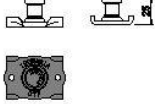
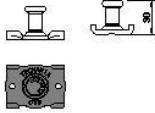
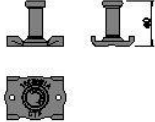
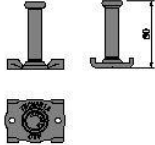
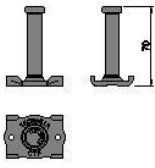
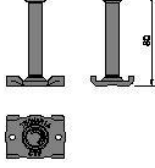
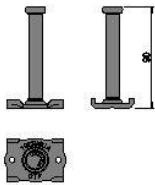
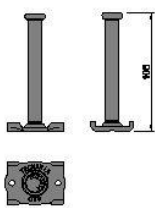
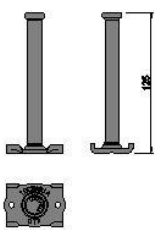
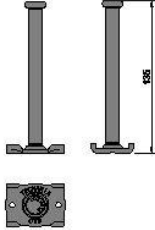
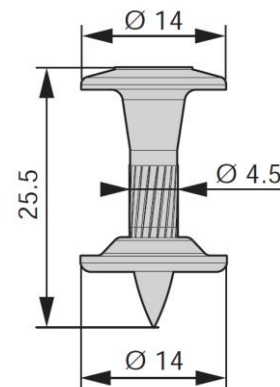

Tecnaria CTF Nailed Shear Connector

Dimensions and materials

Annex A2
of European
Technical Assessment
ETA-18/0447

Use:

The nailed shear connector Tecnaria CTF is intended to be used as connection device between steel and concrete in composite beams and composite decks according to EN 1994-1-1. The nailed shear connector can either be used in new buildings or for the renovation of existing buildings with the aim to increase the bearing capacity of aged floor constructions.

Shear connections of composite structures subject to:

- Static and quasi-static loading.
- In all the configurations in which the connectors are ductile, seismic loading is covered if the CTF connector is used as shear connector in composite beams used as secondary seismic members in dissipative as well as non-dissipative structures according to EN 1998-1..

Base materials:

- Structural steel beams S235, S275 and S355 in qualities JR, JO, J2, K2 according to EN 10025-2. Minimum thickness of the beam flange: where nails are fixed, the steel thickness must be at least 6 mm
- Structural steel decks manufactured according to EN 10346 with yield strength between 220 and 355 N/mm². The nails are nailed through the decking.
- Old steels which cannot be classified accordingly are still applicable provided these are made of unalloyed carbon steel with minimum yield strength f_y of 170 N/mm².

Concrete:

- Normal weight concrete C20/25 – C50/60 according to EN 206 with minimum density 2400 kg/m³
- Lightweight concrete LC20/22 - LC45-50 according to EN 206 with minimum density 1400 kg/m³ (Limit according to the scope of the EAD)

Composite decking:

- Steel for profiled sheeting follows EN 1993-1-3 and the material codes given there. The decking must be manufactured according to EN 10346 and have a yield strength between 220 and 355 N/mm².



Design:

- Design of the composite beams with Tecnaria CTF shear connectors is made according to EN 1994-1-1.
- The Tecnaria CTF connectors are ductile shear connectors according to EN1994-1-1 section 6.6 in the cases listed in tables C1, C2 and C3
- The partial safety factor of $\gamma_v = 1.25$ is used provided no other values are given in national regulations of the member states.

Installation:

- The installation is only carried out according to the manufacturer’s instructions.
- In combination with composite decking the steel sheeting is in direct contact with the steel base material in the area of the connection.
- Transverse reinforcements shall be able to resist the longitudinal shear stress associated with the connection and must be sized and implemented in accordance with the calculation standard EN 1994-1-1 section 6.6.6
- Cartridge selection in order to match the application limit diagram are taken into account, see Annex B3.
- Installation tests are carried out (e.g. mechanical tests and check of nail head standoff h_{nail}), provided the fitness of the recommended cartridge cannot be checked otherwise.

Tecnaria CTF Nailed Shear Connector	Annex B1 of European Technical Assessment ETA-18/0447
Intended use - Specification	

<p>Powder-actuated fastening tools and cartridge, Spitfire P560 nail gun</p> 	<p>Pin drive for CTF connectors (Cod. 013994) Technical characteristics: Weight: 0.730 kg Total length: 163 mm</p> <p>Piston for CTF connectors (Cod. 013997) Technical characteristics: Weight: 0.210 kg Total length: 235 mm</p> <p>Ring stop (Cod. 014136) Weight: 0.210 kg Diameter: 22 mm</p> 
	<p>Safety cartridge calibre 6.3/16 M Circular disc cartridges. Disc with 10 cartridges Power: according to Standards NF E 71.100</p> <ul style="list-style-type: none"> • Yellow: medium load (ref. 031240) • Blue: strong load (ref. 031230) • Red: very strong load (ref. 031220) • Black: extra strong load (ref. 031210)
<p>Tecnaria CTF Nailed Shear Connector</p>	<p>Annex B2 of European Technical Assessment ETA-18/0447</p>
<p>Powder-actuated fastening tool and components</p>	

Applicable range of base material

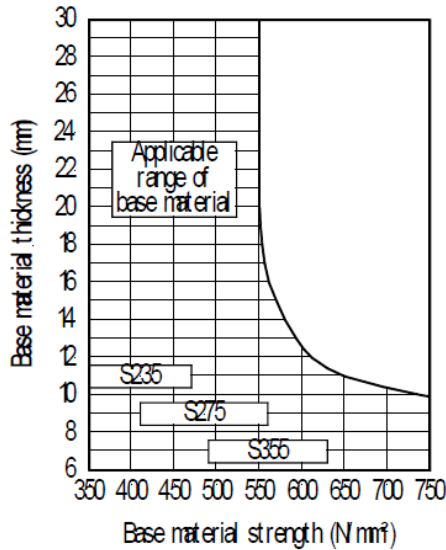

Base material:
Structural steel S235, S275 and S355 according to EN 10025-1:2004; minimum thickness = 6 mm

Cartridge selection

The type of cartridge to be used depends upon the thickness of the flange onto which the connectors are to be fixed and the steel grade of the profile. Consult the diagram below for each fixing situation*).

Flange thickness	S235	S275	S355
6.0	Yellow	Blue	Blue
6.5	Yellow	Blue	Blue
7.0	Yellow	Blue	Blue
7.5	Yellow	Blue	Blue
8.0	Yellow	Blue	Blue
8.5	Blue	Blue	Blue
9.0	Blue	Blue	Red
10.00	Blue	Blue	Red
10.20	Blue	Blue	Red
10.70	Blue	Blue	Red
11.50	Blue	Red	Black
12.70	Blue	Red	Black
13.50	Blue	Red	Black
14.60	Blue	Red	Black
16.00	Red	Black	Black
17.50	Red	Black	Black
19.00	Red	Black	Black

Table II

Indicative values: we recommend carrying out tests on site to confirm the choice

Checking nail penetration

To confirm this choice, two tests should be performed:

- a visual check
- a mechanical check.

To confirm the choice of cartridge, the two tests must be satisfactory.

Check while work is in progress

- During nailing, a continuous visual check should be performed.
- In addition, a mechanical check is to be performed after every 250 nailed connector.

Treatment of connector assemblies with insufficient penetration

When work is in progress, if the visual test is not satisfactory, a mechanical inspection should be performed to ensure the validity of nailing. If the mechanical check is satisfactory, the series can be kept. Otherwise the faulty connectors must be replaced.

Visual check

To ensure that the connectors are properly fixed, the penetration of the nails should be checked by measuring the distance from the head of the nail to the flat part of the base plate of the connector. This measurement is performed using the card (orange) supplied with the connectors.

The admissible value h_{nail} varies from 3.5 mm (maximum) to 7.5 mm (minimum).

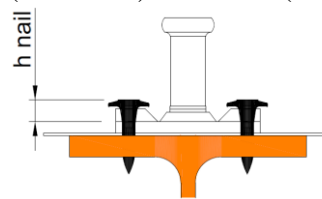

Values < 3.5 mm (maximum):

In this case the nail is pushed too far in. However, these values do not cast doubt on the resistance of the connector. However, it would be advisable to lower the power level of the loads used in order to avoid any risk of premature breakage of the gun.

Values > 7.5 mm (minimum):

When the 7.5 mm limit value is exceeded, the nail is not pushed far enough in and the test is considered unsatisfactory

*) A fixing situation is characterized by a set of parameters that can influence the nailing result: thickness of the profile flange, steel grade, thickness of the steel deck, etc. Each time one of these characteristics changes, the nailing system must be reconfirmed.

Tecnaria CTF Nailed Shear Connector

Annex B3
of European
Technical Assessment
ETA-18/0447

Application limit, cartridge selection and fastener inspection

Mechanical check of the connector fixture

This check is partly destructive for the connector. It will therefore be necessary to fit a new one next to the connector tested.

The test consists of placing a tube on the shank of the connector and bending the shank at least 45° to either side of the connector to stress the two nails one after the other, without the nails coming out of their original position.

If the connector remains in place and if the base plate adheres perfectly to the support, it means that the fixture is correct.

Otherwise the fixture is considered faulty.

N.B.: the fastening of the connector remains satisfactory even if play is observed between the shank and the base of the connector.

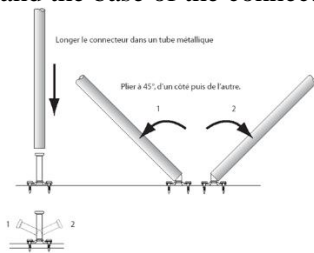

The installation of connectors must be entrusted to qualified persons who have read and understood the information in this manual for their implementation.

Tecnaria CTF Nailed Shear Connector

Application limit, cartridge selection and fastener inspection

Annex B3.1
of European
Technical Assessment
ETA-18/0447

Composite beams without steel decking

As a rule, it is preferable to arrange the connectors transversely to the axis of the beam

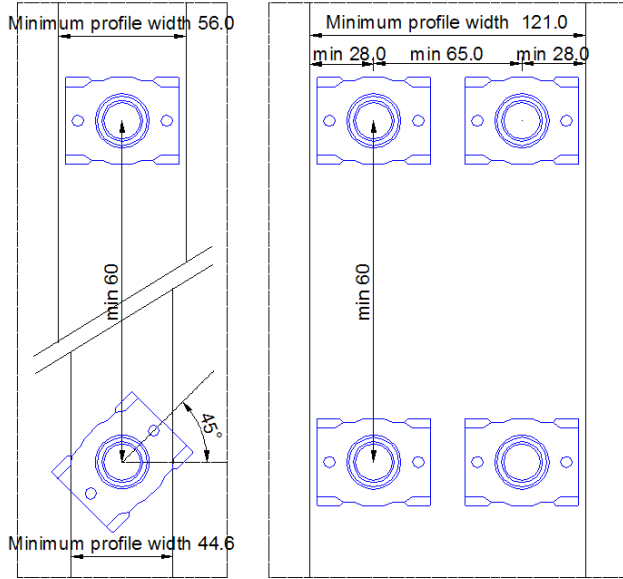

Minimum thickness of the profile flange where the nails are to be fixed: 6 mm.

- Maximum longitudinal spacing of the connectors: 6 times the slab thickness or 800 mm
- Minimum spacing: 60 mm

Composite beams with steel decking

CTF connectors should be placed perpendicular to the beam axis and parallel to the steel decking profiles

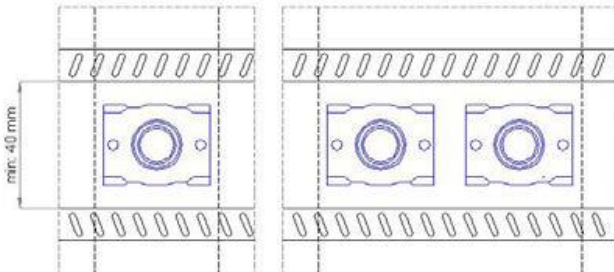

- Maximum spacing of the connectors: 6 times the slab thickness or 800 mm
- Minimum spacing: 60 mm

Tecnaria CTF Nailed Shear Connector

Positioning in composite beams with solid concrete slabs

Annex B4
of European
Technical Assessment
ETA-18/0447

Table C1 Characteristic and design resistance in solid concrete decks, shear connector orientation perpendicular to beam axis ^{1) and 2)}. Minimum base material thickness 8 mm. For base material thickness less than 8 mm, see page 18

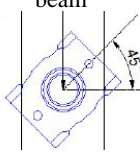
Shear connector	Concrete class	Characteristic Resistance P_{Rk} [kN]	Design resistance P_{Rd} [kN]	Tecnaria CTF positioning	Ductility assessment according to EN 1994-1-1
CTF 020	C20/25	14,2	11,4	Perpendicular to the axis of the beam 	Non-ductile
CTF 025		17,8	14,2		Non-ductile
CTF 030		21,4	17,1		Non-ductile
CTF 040 CTF 060 CTF 070		28,5	22,8		Non-ductile
CTF 080 CTF 090 CTF 105 CTF 125 CTF 135		38,1	30,5		Ductile
CTF 020	C25/30	17,1	13,7		Non-ductile
CTF 025		21,4	17,1		Non-ductile
CTF 030		25,6	20,5		Non-ductile
CTF 040 CTF 060 CTF 070		34,2	27,3		Non-ductile
CTF 080 CTF 090 CTF 105 CTF 125 CTF 135		45,8	36,6		Ductile
CTF 020	C30/37	19,3	15,5		Non-ductile
CTF 025		24,1	19,3		Non-ductile
CTF 030		29,0	23,2		Non-ductile
CTF 040 CTF 060 CTF 070		38,6	30,9		Non-ductile
CTF 080 CTF 090 CTF 105 CTF 125 CTF 135		46,4	37,1		Ductile
CTF 020	C32/40	19,3	15,5		Non-ductile
CTF 025		24,1	19,3		Non-ductile
CTF 030		29,0	23,2		Non-ductile
CTF 040 CTF 060 CTF 070		38,6	30,9		Non-ductile
CTF 080 CTF 090 CTF 105 CTF 125 CTF 135		46,4	37,1		Ductile
CTF 020	C35/45 or greater	26,7	21,4	Non-ductile	
CTF 025		33,4	26,7	Non-ductile	
CTF 030		40,1	32,1	Non-ductile	
CTF 040 CTF 060 CTF 070		46,4	37,1	Ductile	
CTF 080 CTF 090 CTF 105 CTF 125 CTF 135		46,4	37,1	Ductile	
CTF 020	LC20/22 LC25/28	19,5	15,6	Non-ductile	
CTF 025		24,3	19,5	Non-ductile	
CTF 030		29,2	23,3	Non-ductile	
CTF 040 CTF 060 CTF 070		38,9	31,1	Non-ductile	
CTF 080 CTF 090 CTF 105 CTF 125 CTF 135		38,9	31,1	Ductile	
CTF 020	LC30/33 LC40/44	19,5	15,6	Non-ductile	
CTF 025		24,3	19,5	Non-ductile	
CTF 030		29,2	23,3	Non-ductile	
CTF 040 CTF 060 CTF 070		38,9	31,1	Non-ductile	
CTF 080 CTF 090 CTF 105 CTF 125 CTF 135		38,9	31,1	Ductile	
CTF 020	LC45/50 LC50/55	19,5	15,6	Non-ductile	
CTF 025		24,3	19,5	Non-ductile	
CTF 030		29,2	23,3	Non-ductile	
CTF 040 CTF 060 CTF 070		38,9	31,1	Non-ductile	
CTF 080 CTF 090 CTF 105 CTF 125 CTF 135		38,9	31,1	Ductile	
CTF 020	C20/25	18,7	15,0	At 45° to the axis of the beam 	Non-ductile
CTF 025		23,4	18,7		Non-ductile
CTF 030		28,1	22,4		Non-ductile
CTF 040 CTF 060 CTF 070		37,4	29,9		Non-ductile
CTF 080 CTF 090 CTF 105 CTF 125 CTF 135		37,4	29,9		Ductile
CTF 020	C25/30	22,4	18,0		Non-ductile
CTF 025		28,1	22,4		Non-ductile
CTF 030		33,7	26,9		Non-ductile
CTF 040 CTF 060 CTF 070		44,9	35,9		Non-ductile
CTF 080 CTF 090 CTF 105 CTF 125 CTF 135		44,9	35,9		Ductile
CTF 020	C30/37	22,4	18,0		Non-ductile
CTF 025		28,1	22,4		Non-ductile
CTF 030		33,7	26,9		Non-ductile
CTF 040 CTF 060 CTF 070		44,9	35,9		Non-ductile
CTF 080 CTF 090 CTF 105 CTF 125 CTF 135		44,9	35,9		Ductile
CTF 020	C35/45	24,4	19,5		Non-ductile
CTF 025		30,5	24,4		Non-ductile
CTF 030		36,5	29,2		Non-ductile
CTF 040 CTF 060 CTF 070		46,4	37,1		Ductile
CTF 080 CTF 090 CTF 105 CTF 125 CTF 135		46,4	37,1		Ductile
CTF 020	LC20/22 LC25/28	20,1	16,1	Non-ductile	
CTF 025		25,1	20,1	Non-ductile	
CTF 030		30,1	24,1	Non-ductile	
CTF 040 CTF 060 CTF 070		40,1	32,1	Non-ductile	
CTF 080 CTF 090 CTF 105 CTF 125 CTF 135		40,1	32,1	Ductile	
CTF 020	LC30/33 LC40/44	20,1	16,1	Non-ductile	
CTF 025		25,1	20,1	Non-ductile	
CTF 030		30,1	24,1	Non-ductile	
CTF 040 CTF 060 CTF 070		40,1	32,1	Non-ductile	
CTF 080 CTF 090 CTF 105 CTF 125 CTF 135		40,1	32,1	Ductile	
CTF 020	LC45/50 LC50/55	20,1	16,1	Non-ductile	
CTF 025		25,1	20,1	Non-ductile	
CTF 030		30,1	24,1	Non-ductile	
CTF 040 CTF 060 CTF 070		40,1	32,1	Non-ductile	
CTF 080 CTF 090 CTF 105 CTF 125 CTF 135		40,1	32,1	Ductile	

1) in the absence of other national regulation, a partial safety factor of $\gamma_v = 1,25$ applies

2) Lightweight concrete with a minimum density $\rho = 1400 \text{ kg/m}^3$

Tecnaria CTF Nailed Shear Connector

Characteristic resistance in solid concrete decks, shear connector orientation perpendicular to beam axis

Annex C1

of European Technical Assessment
ETA-18/0447

Table C2 Design resistance in composite decks – decking ribs perpendicular to beam axis – shear connector orientation perpendicular to beam axis

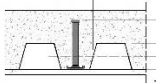
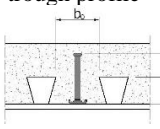
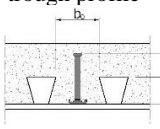
CTF positioning			Concrete class	Design resistance PRd [kN] (3)	Ductility assessment according to EN 1994-1-1	
Type of connector	nr (1)	type of metal deck (2)				
CTF 080	1	Open trough profile 	C25/30 or LC20/22-LC50/55	= k _t x 31.9	Non-ductile	
CTF 090 CTF 105	1				Ductile	
CTF 125 CTF 135	1				Ductile	
CTF 080	1				Non-ductile	
CTF 090 CTF 105	1		C30/37	= k _t x 33.4	Ductile	
CTF 125 CTF 135	1				Ductile	
CTF 080	1		C35/45	= k _t x 34.6	Non-ductile	
CTF 090 CTF 105	1				Ductile	
CTF 125 CTF 135	1		Ductile			
CTF 080 CTF 090 CTF 105	2 or plus		Re-entrant trough profile 	C25/30 or LC20/22-LC50/55	= k _t x 31.9	Non-ductile
CTF 125 CTF 135	2 or plus					Ductile
CTF 080 CTF 090 CTF 105	2 or plus			C30/37	= k _t x 33.4	Non-ductile
CTF 125 CTF 135	2 or plus					Ductile
CTF 080 CTF 090 CTF 105	2 or plus			C35/45	= k _t x 34.6	Non-ductile
CTF 125 CTF 135	2 or plus	Ductile				
CTF 080 CTF 090 CTF 105 CTF 125 CTF 135	any	Re-entrant trough profile 		C25/30 or LC20/22-LC50/55	= k _t x 31.9	Non-ductile
CTF 080 CTF 090 CTF 105 CTF 125 CTF 135	any					C30/37
CTF 080 CTF 090 CTF 105 CTF 125 CTF 135	any			C35/45	= k _t x 34.6	Non-ductile

- (1) nr = 1 if one connector per rib,
nr = 2 if two or more connectors per rib.
- (2) Open trough profile has b < b₀
Re-entrant profile has b > b₀

$$(3) k_t = \frac{0.7}{\sqrt{n_r}} \cdot \frac{b_0}{h_p} \cdot \left(\frac{h_{sc}}{h_p} - 1 \right) \leq k_{t,max}$$

The symbols are defined in the following figure:

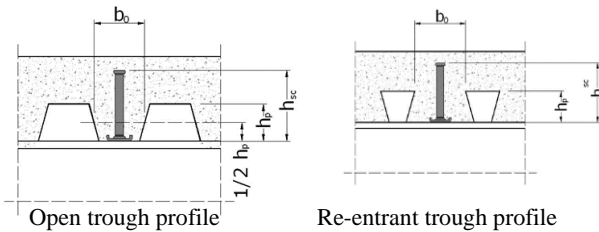

Nr	Thickness of metal decking (mm)	Kt,max
1	≤ 1.0	0.85
1	> 1.0	1.00
≥2	≤ 1.0	0.70
≥2	> 1.0	0.80

The connectors are arranged in ribs having a height hp not exceeding 85 mm and a width b₀ of at least hp .

Tecnaria CTF Nailed Shear Connector	Annex C2 of European Technical Assessment ETA-18/0447
Design resistance in composite decks – decking ribs perpendicular to beam axis – shear connector orientation perpendicular to beam axis	

Table C3 Floor with steel decking with ribs laid perpendicular to the beam and C35/45 class concrete:

Type	Metal deck:	Connectors per rib – nr	Design resistance Prd – kN	Ductility
CTF080	Cofraplus 40 Arcelor Mittal	1	34.84	Non-ductile
CTF125	Cofraplus 77 Arcelor Mittal	1	25.01	Ductile

Tecnaria CTF Nailed Shear Connector

Design resistance in composite decks - Floor with steel decking with ribs laid perpendicular to the beam and C35/45 class concrete

Annex C3
of European
Technical Assessment
ETA-18/0447

Table C4. Design resistance in composite decks – decking ribs parallel to beam axis – shear connector orientation perpendicular to beam axis

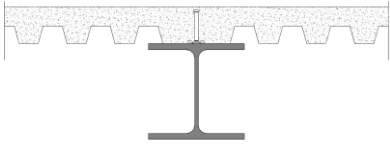
CTF positioning	Design resistance $PR_{d,l}$ [kN] (1)	Ductility assessment according to EN 1994-1-1
	$PR_{d,l} = k_l * PR_d$	Ductility same as table C1 for solid concrete slab ductility

(1)

$$k_l = 0.6 \cdot \frac{b_0}{h_p} \cdot \left(\frac{h_{sc}}{h_p} - 1 \right) \leq 1 \quad (\text{measures in mm})$$

PR_d is the design resistance for solid concrete slabs according to Annex C1, table C1

h_{sc} is the overall height of the connector, but not greater than $h_p + 75$ mm.

CTF connectors are to be positioned perpendicular to the beam or at 45°

When the steel decking is continuous over the beam, the width of the haunch b_0 is equal to the width of the concrete rib as shown in the following figures:

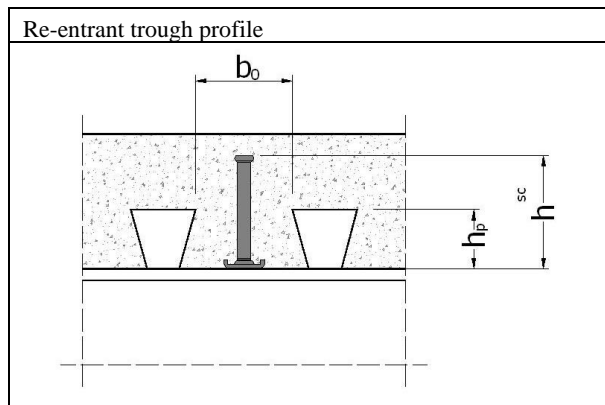
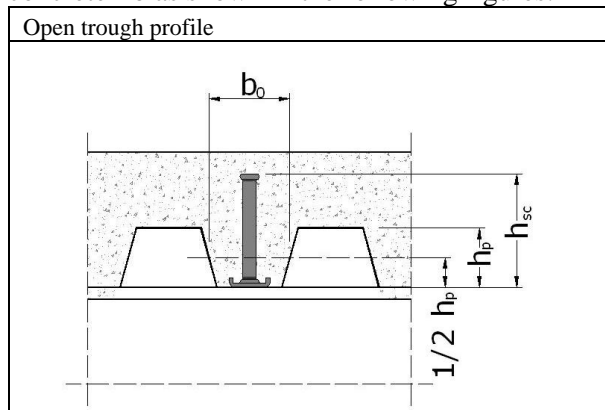

Tecnaria CTF Nailed Shear Connector	Annex C4 of European Technical Assessment ETA-18/0447
Design resistance in composite decks – decking ribs parallel to beam axis – shear connector orientation parallel to beam axis	

When the steel decking is not continuous over the beam, b_0 is defined as indicated in the following figures:

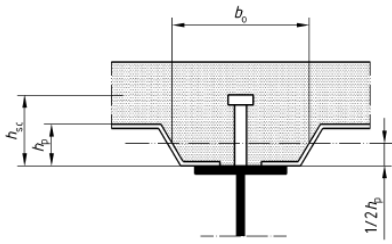

Figure 7.4a

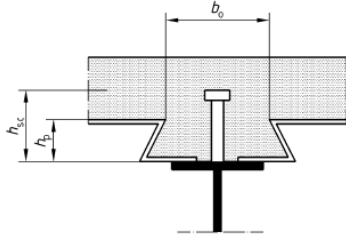

Figure 7.4b

It is necessary to take the haunch height equal to h_p , total height of the steel deck (cf. figures).

The height of the haunch should be equal to h_p , total height of the decking excluding projections.

Tecnaria CTF Nailed Shear Connector

Design resistance in composite decks – decking ribs parallel to beam axis – shear connector orientation perpendicular to beam axis, continued

Annex C5
of European
Technical Assessment
ETA-18/0447

Design resistance: Effect of reduced base material thickness for CTF Connectors

Reduction of design resistance P_{rd} with the factor $(t_{II,act} / 8)$ is required in case the actual base material thickness is less than 8 mm.

$$P_{Rd,red} = \frac{t_{II,act}}{8} P_{Rd}$$

With:

$P_{Rd,red}$ = reduced design resistance of CTF connectors for actual base material thickness $t_{II,act} < 8$ mm and a minimum thickness of 6 mm.

P_{Rd} = design resistance of the connectors

No extrapolation of above formula for base material thickness $t_{II,act} > 8$ mm.

This reduction of resistance is not added to the possible reduction of resistance due to metal decking. The factor resulting in the largest reduction is used.

Design resistance: Effect of reduced base material strength

Reduction of design resistance P_{rd} with the factor $\alpha_{BM,red}$ is required in case the actual base material minimum yield strength of the old construction steel is less than 235 N/mm²

- minimum yield strength $f_y = 170$ N/mm²

$$P_{Rd,red} = \alpha_{BM,red} \times P_{Rd}$$

$$\alpha_{BM,red} = 0.81$$

with:

$P_{Rd,red}$ = reduced design strength of the connector

This reduction of resistance is not added to the possible reduction of resistance due to metal decking. The factor resulting in the largest reduction is used.

Tecnaria CTF Nailed Shear Connector	Annex C6 of European Technical Assessment ETA-18/0447
Effect of reduced base material thickness for Tecnaria CTF Effect of reduced base material strength	